

# SUTTLE

## Structured Cabling

2-7030-24  
Patch Panel  
Cat.5e - 24-Port

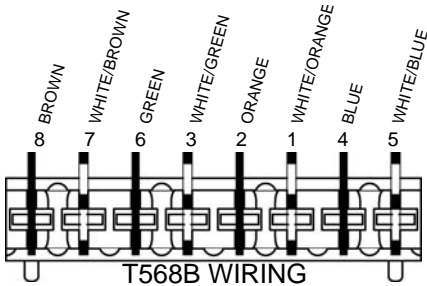
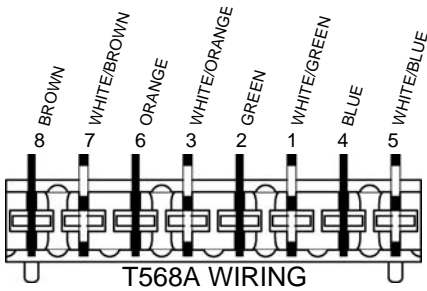
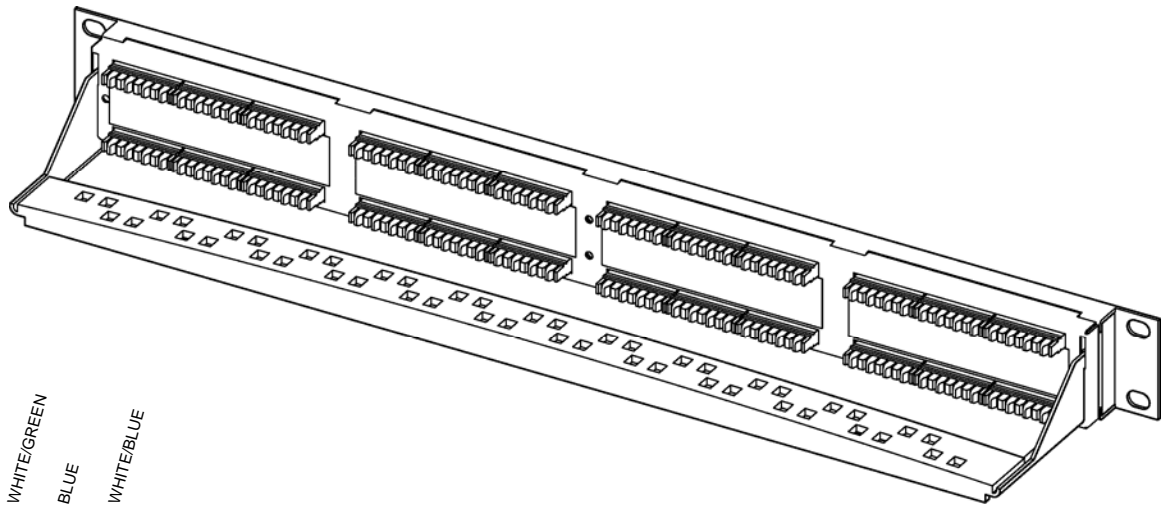
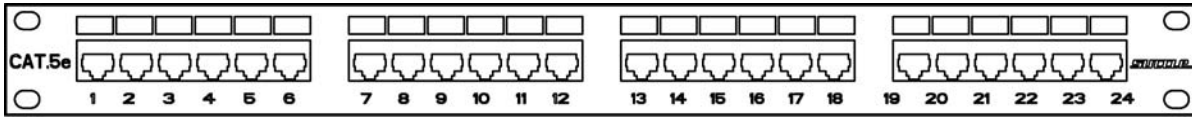

Strip cable jacket approximately 1 1/2". Insert wires into IDC according to the desired wiring configuration (T568A/T568B). Do not untwist wire pairs more than 1/2" from termination point

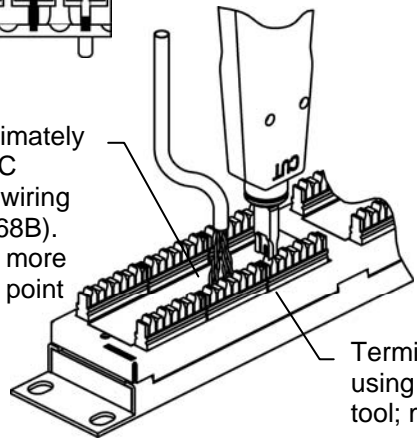

Terminate wires using an impact tool; make sure excess wires are trimmed off.

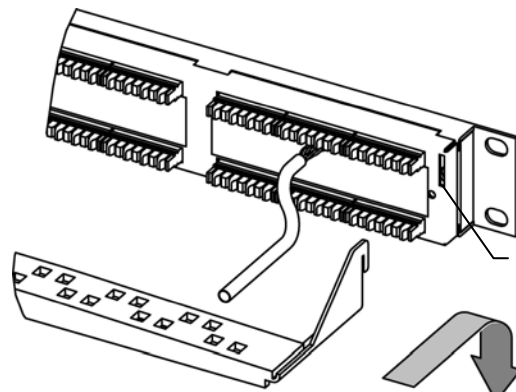

Attach wire management bracket to the back of the patch panel.

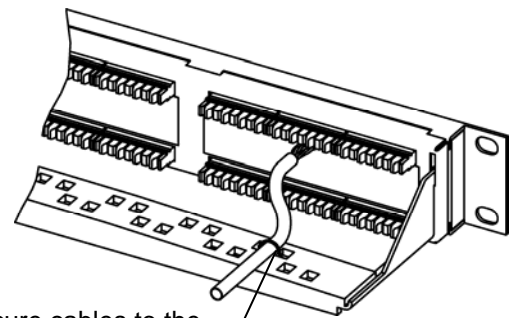

Secure cables to the wire management bracket with zip ties.